

Name: _____

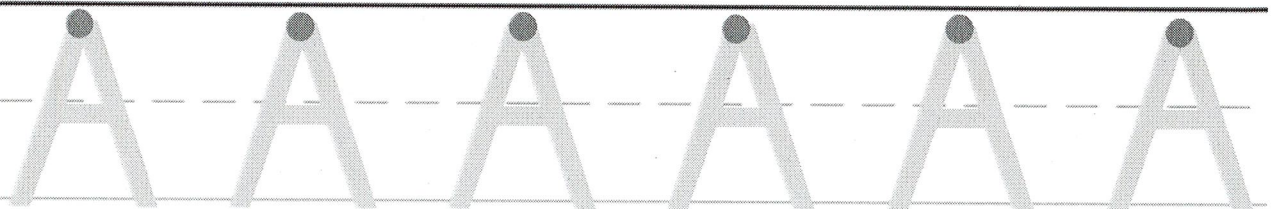

Name: _____

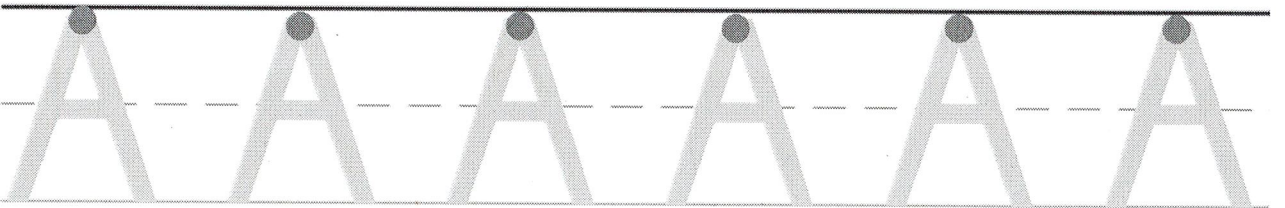
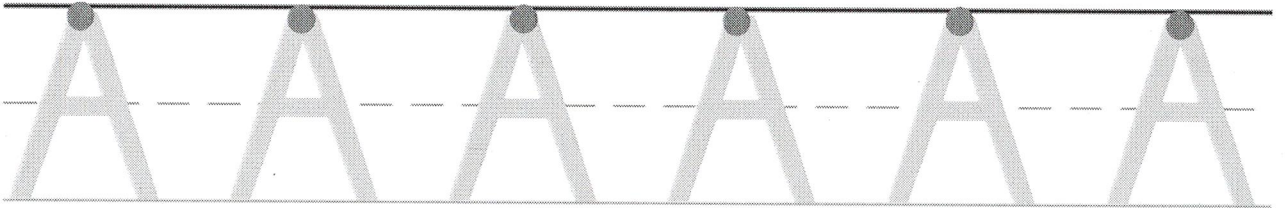
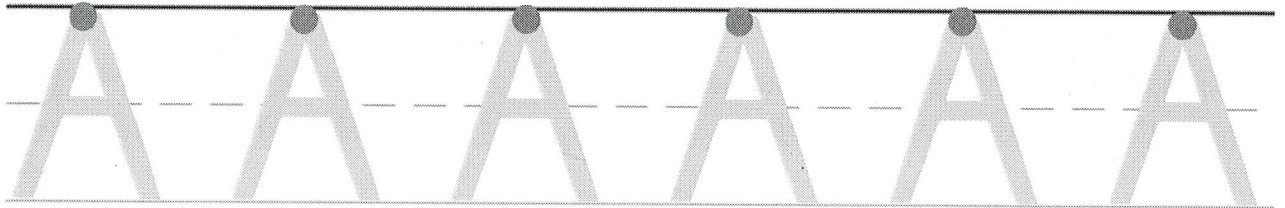
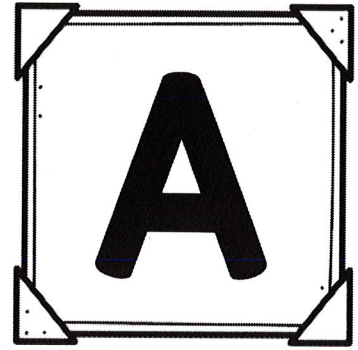
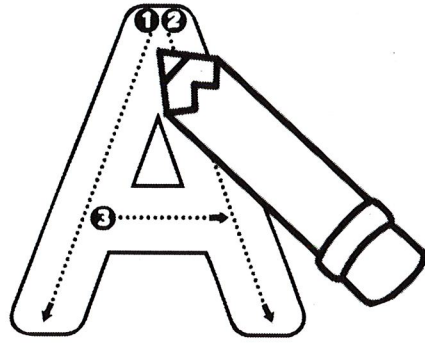
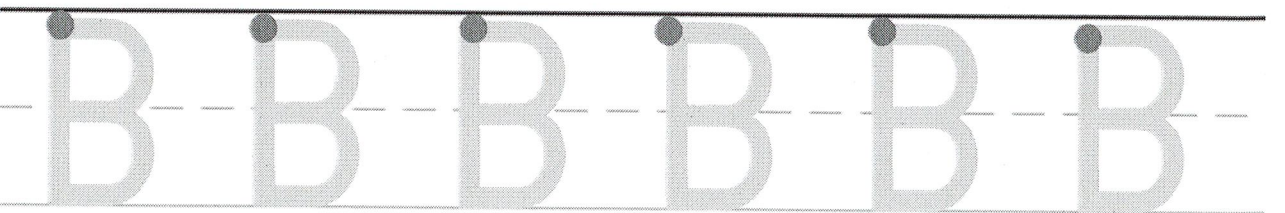
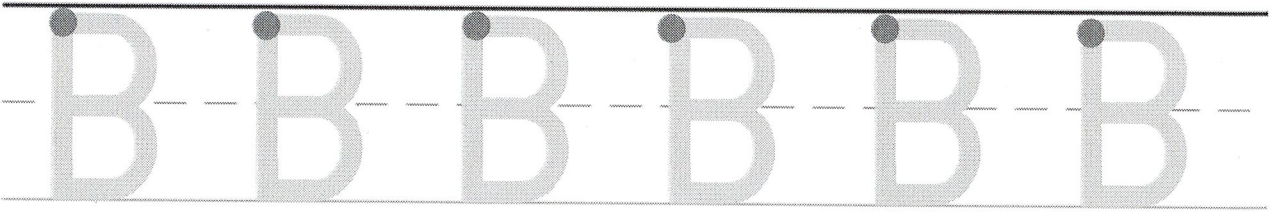
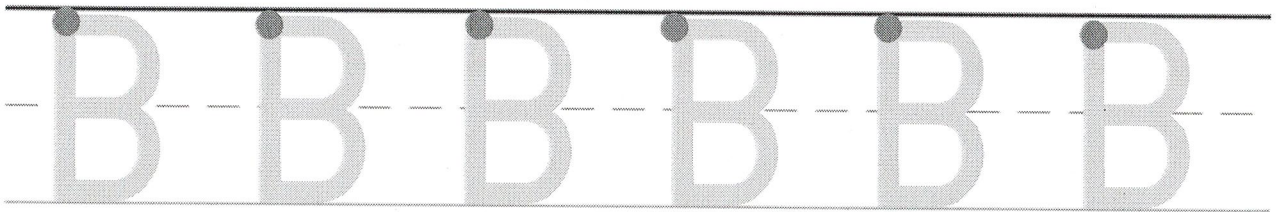
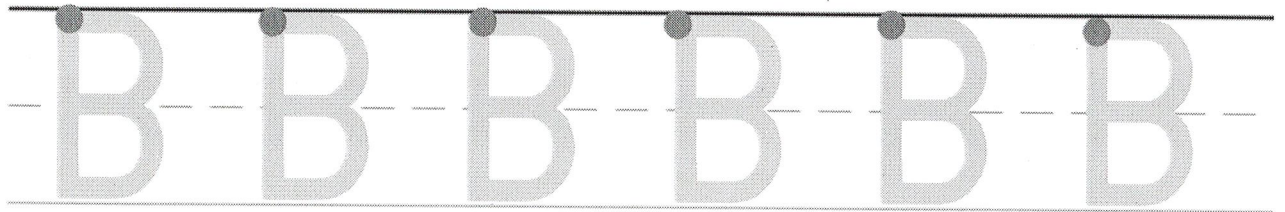
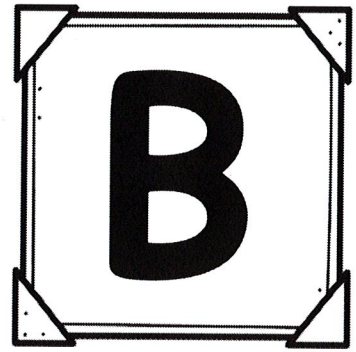
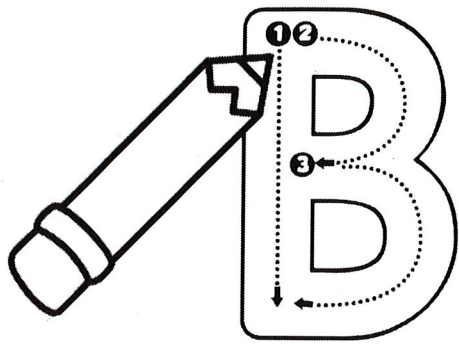

Name: _____

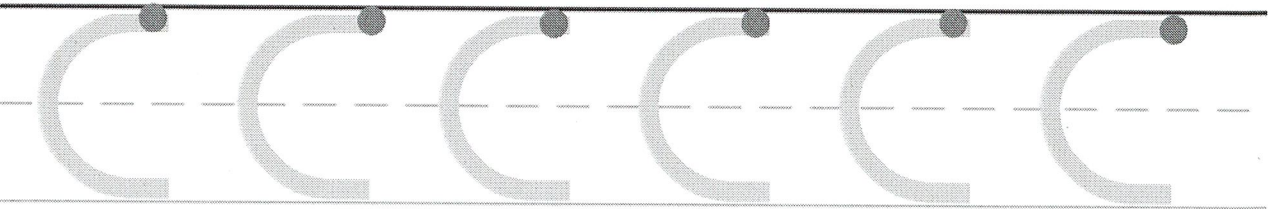
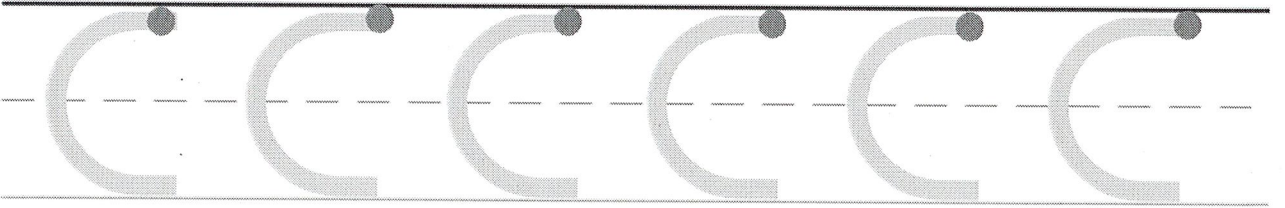
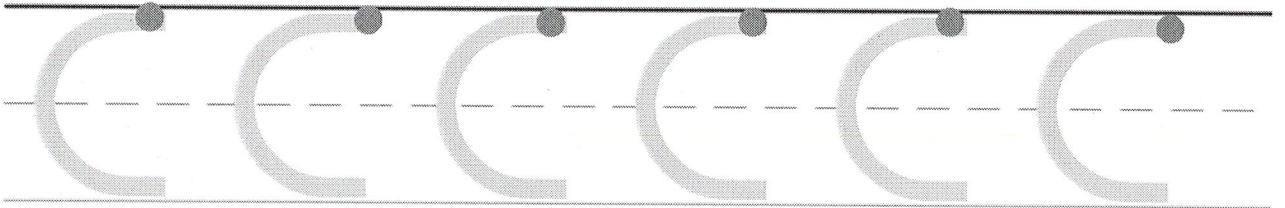
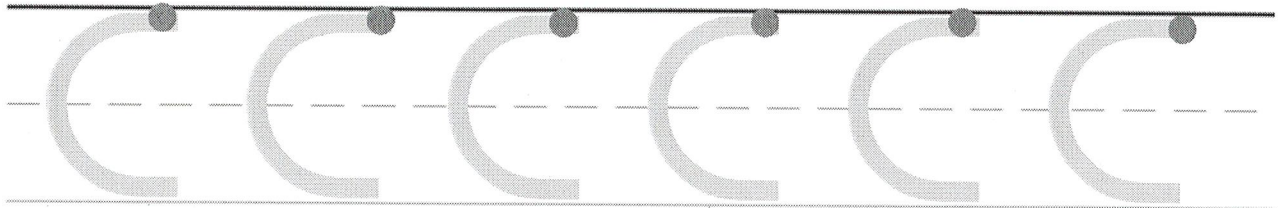
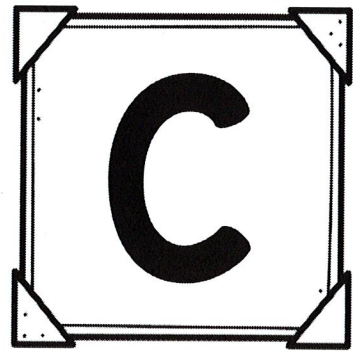
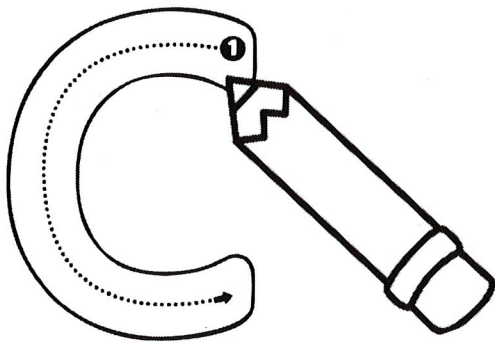

Name: _____

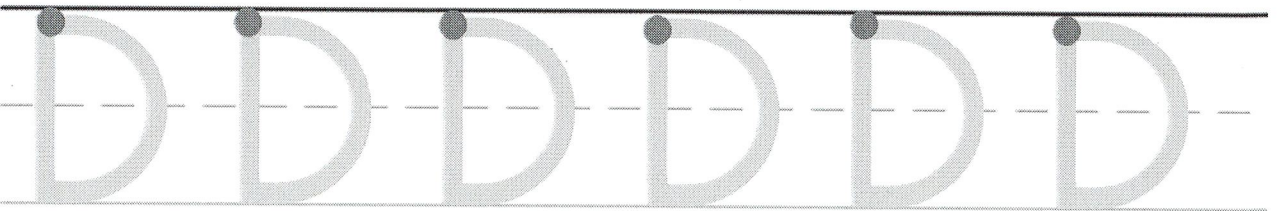
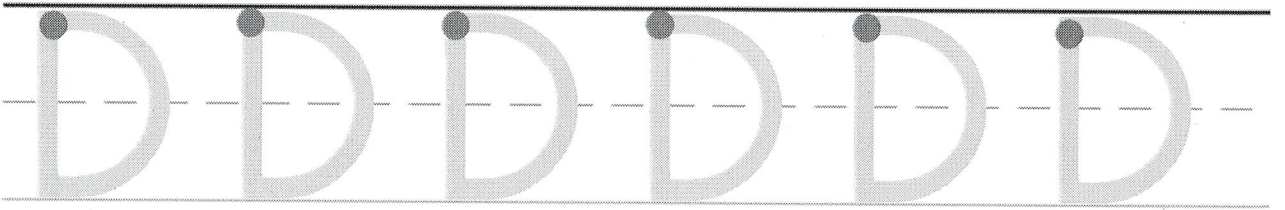
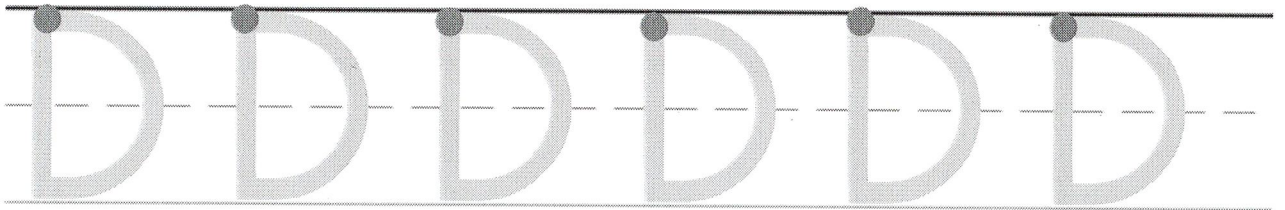
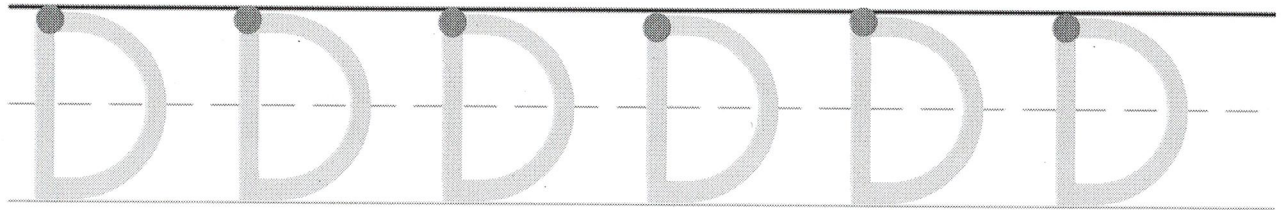
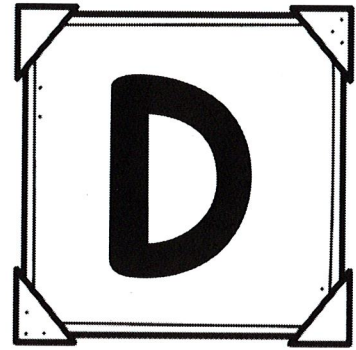
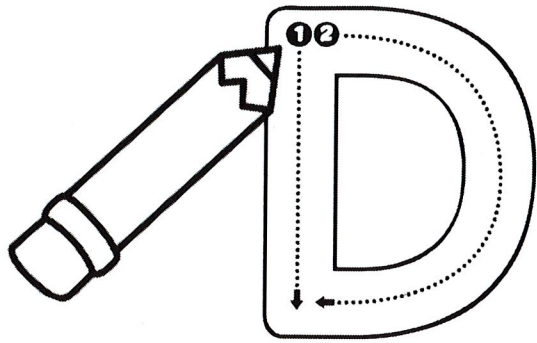

Name: _____

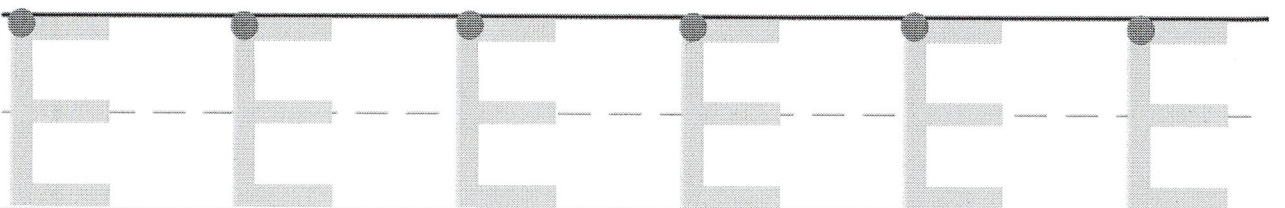
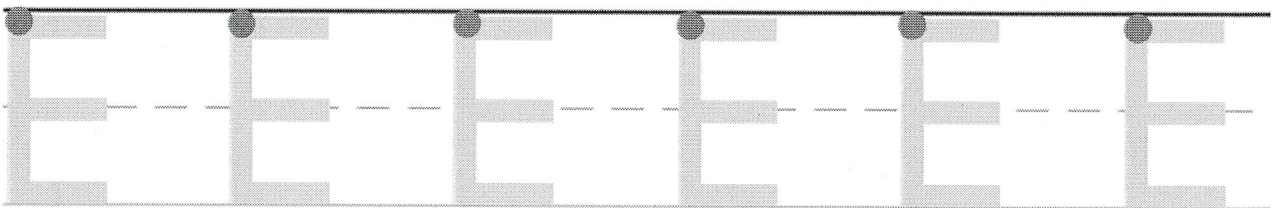
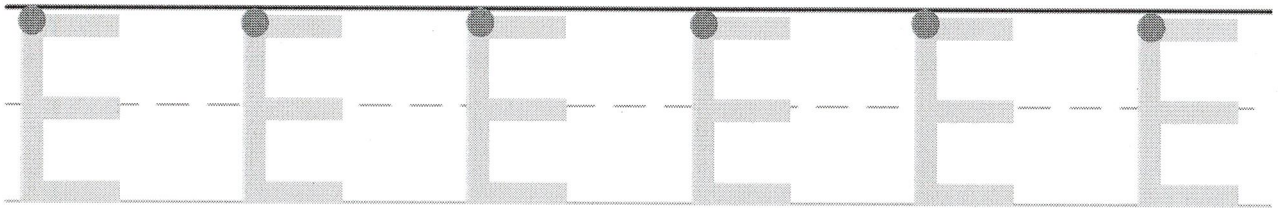
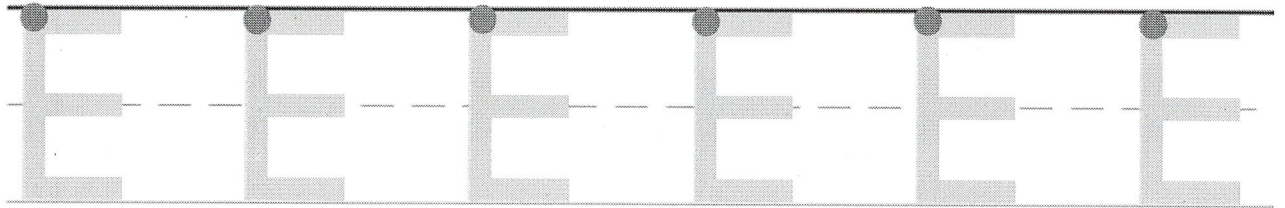
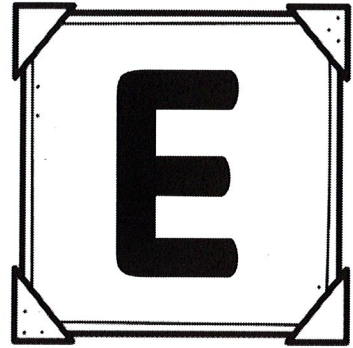
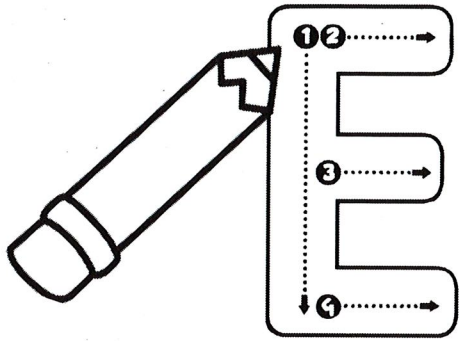

Name: _____

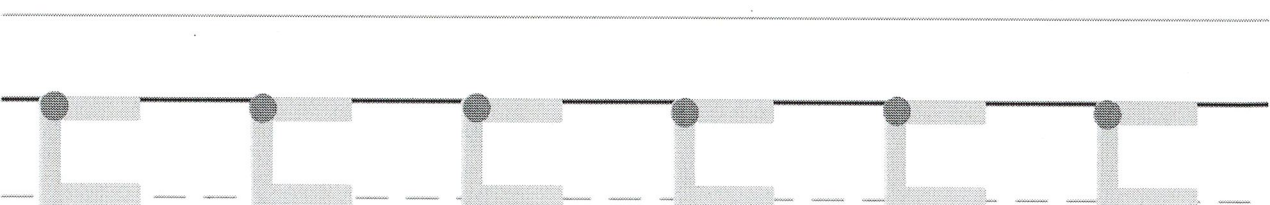
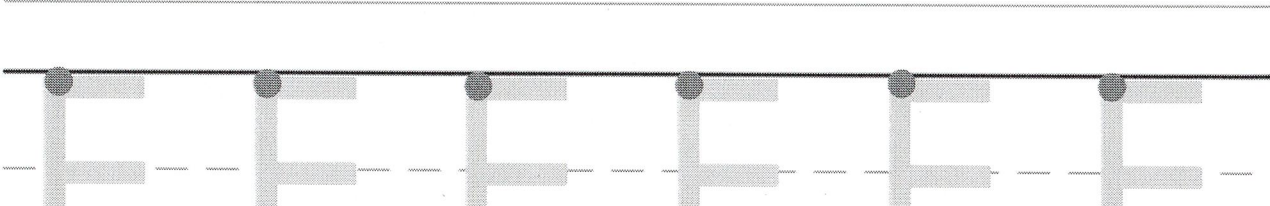
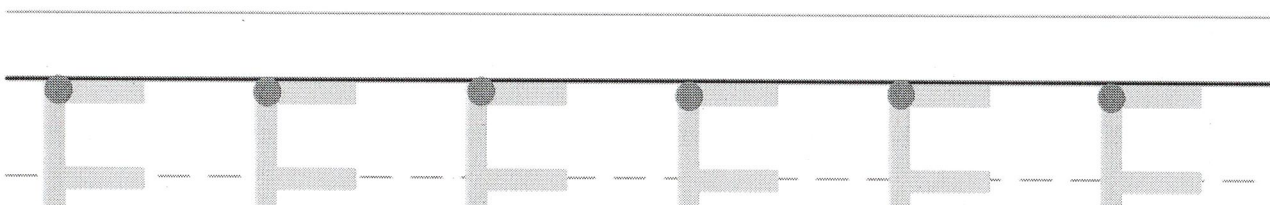
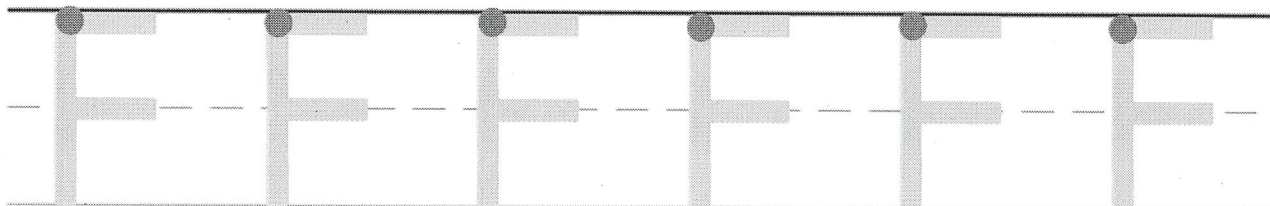
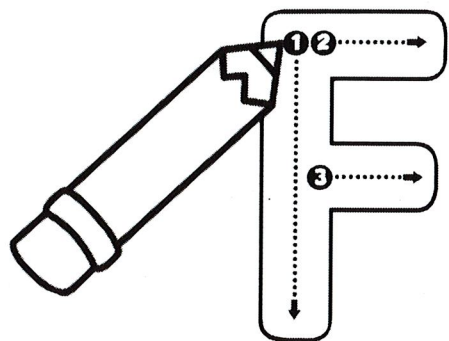

Name: _____

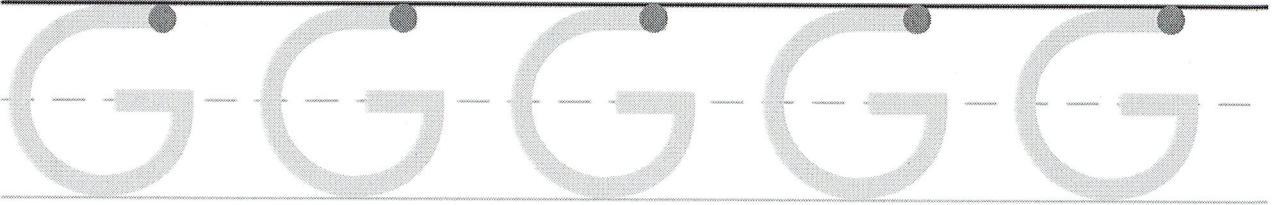
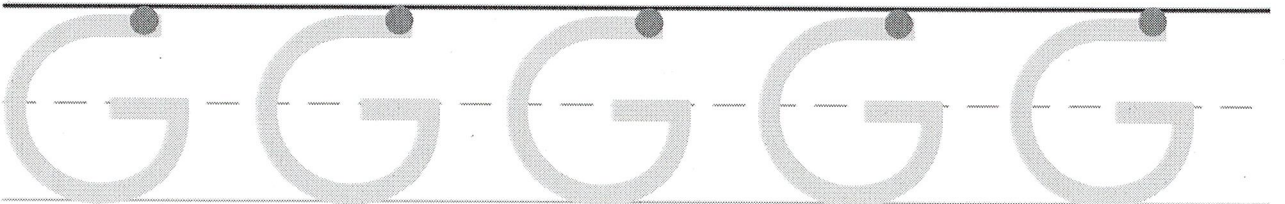
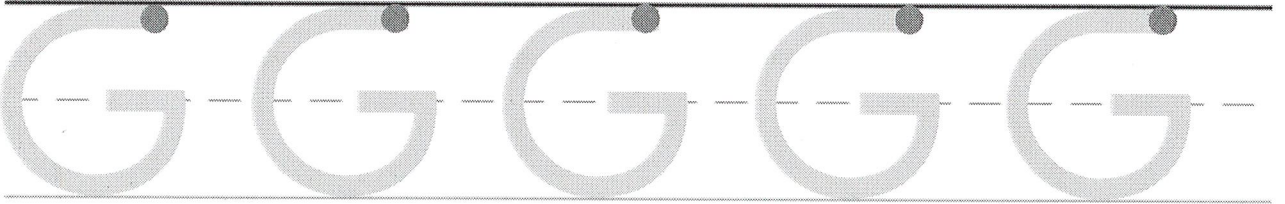
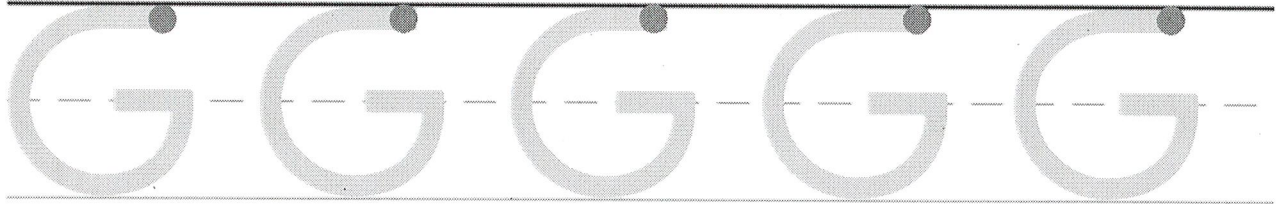
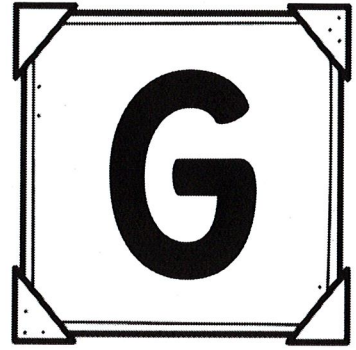
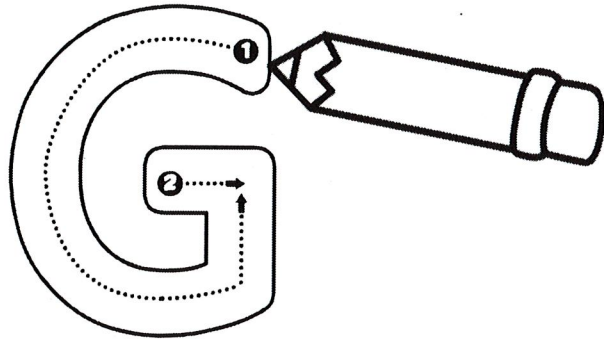

Name: _____

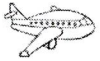
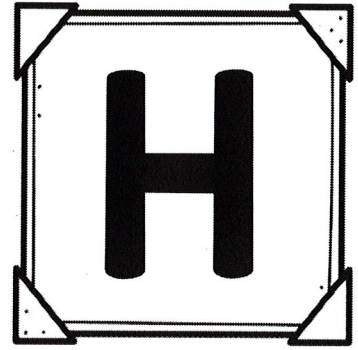
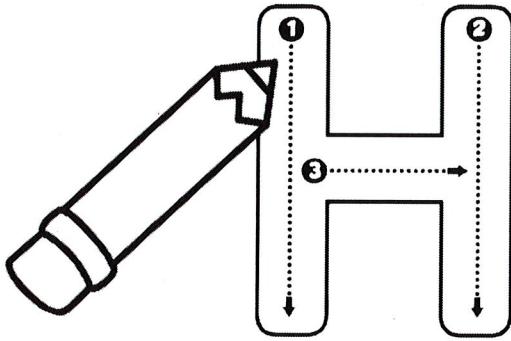

Handwriting practice area consisting of four rows of three-line guides (top, middle dashed, bottom). Each row contains seven faint uppercase 'H' characters for tracing. A solid black dot is placed at the top of each 'H' to indicate the starting point for the first stroke.

Name: _____

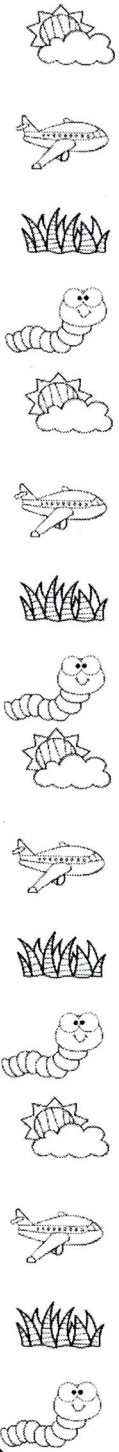
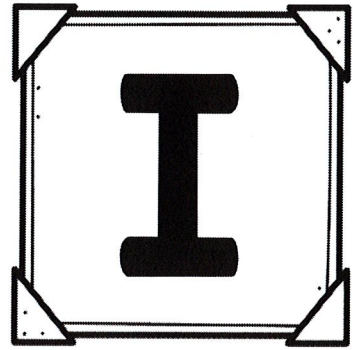
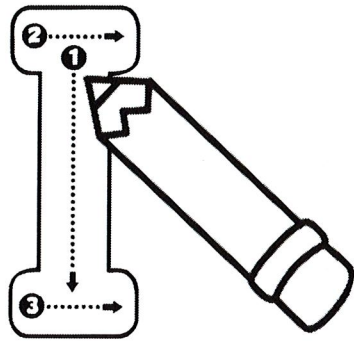

Handwriting practice area consisting of four rows of three-line guides (top solid, middle dashed, bottom solid). Each row contains six dashed uppercase 'I' characters for tracing. The first row is shaded gray, while the others are white.

Name: _____

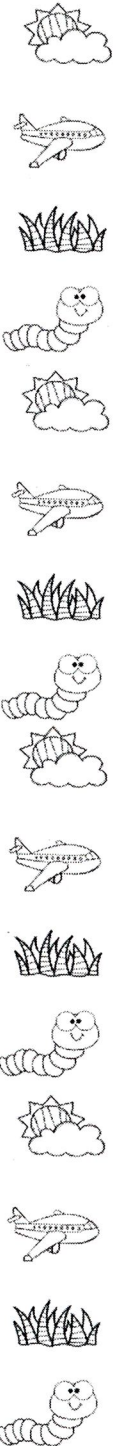
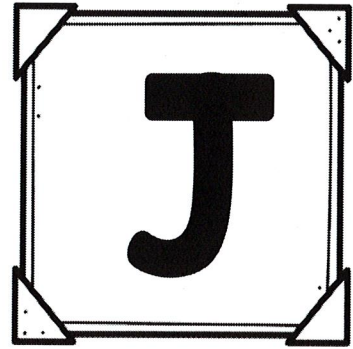
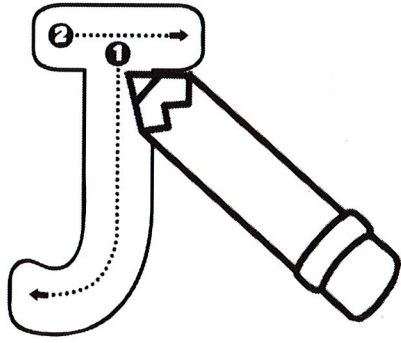

Handwriting practice area consisting of four rows of three-line guides (top, middle dashed, bottom). Each row contains six light gray uppercase 'J' characters for tracing. The first row has a solid black dot at the top of each 'J' stem. The second row has a solid black dot at the top of each 'J' stem. The third row has a solid black dot at the top of each 'J' stem. The fourth row has a solid black dot at the top of each 'J' stem.

Name: _____

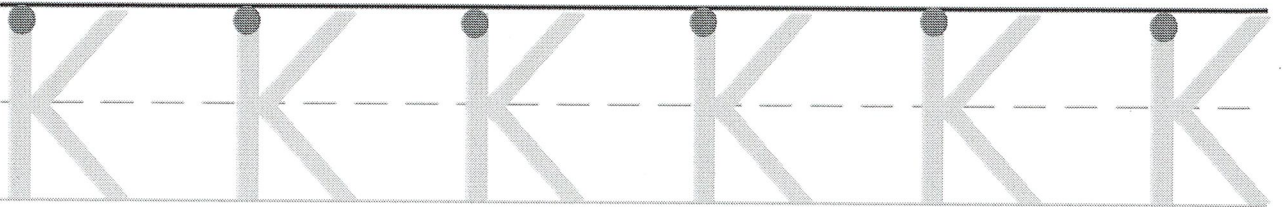
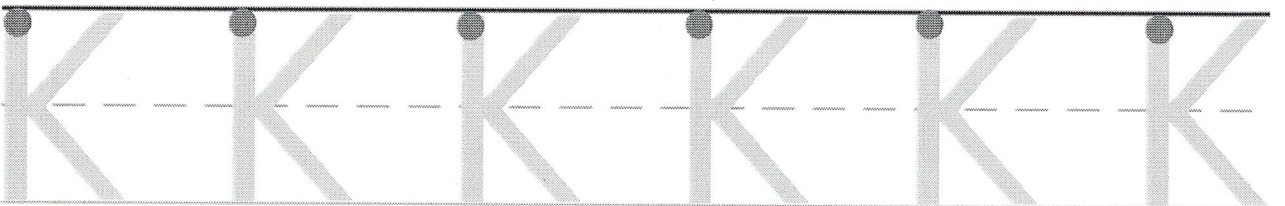
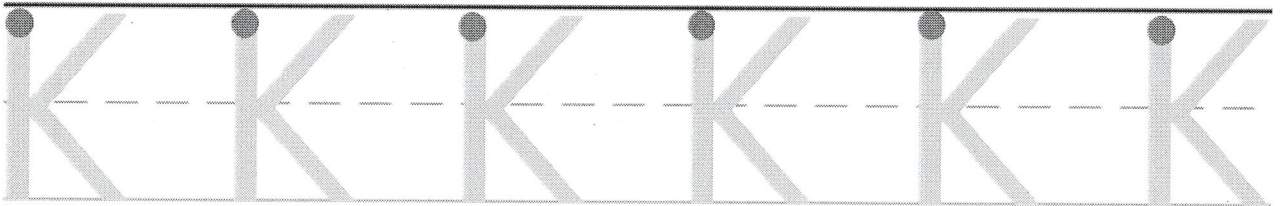
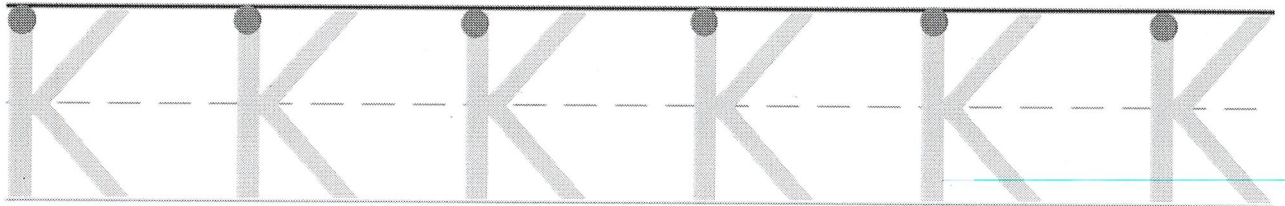
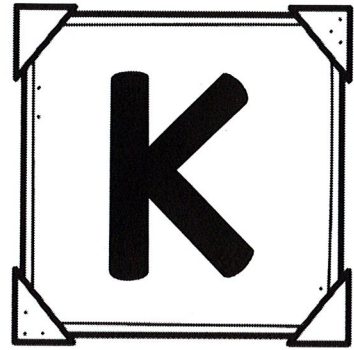
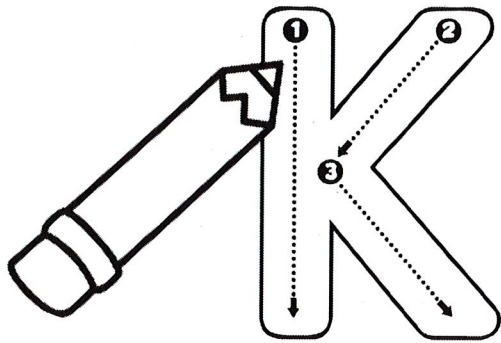

Name: _____

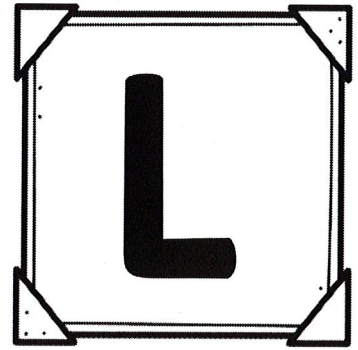
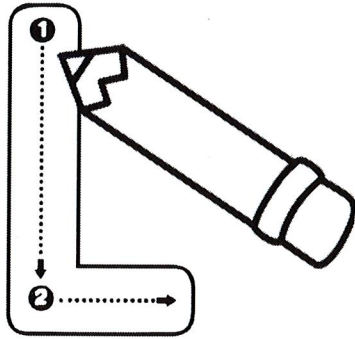

Handwriting practice section consisting of four rows of three-line guides (top solid line, middle dashed line, bottom solid line). Each row contains seven faint, grey 'L' characters for tracing. The first row has a solid black dot at the top of each 'L' stem. The second row has a solid black dot at the top of each 'L' stem. The third row has a solid black dot at the top of each 'L' stem. The fourth row has a solid black dot at the top of each 'L' stem.

Name: _____

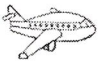
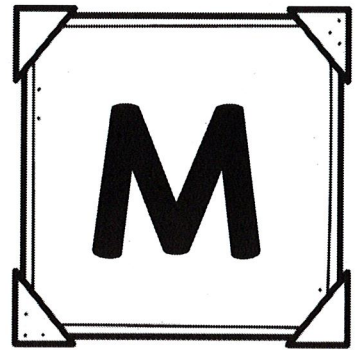
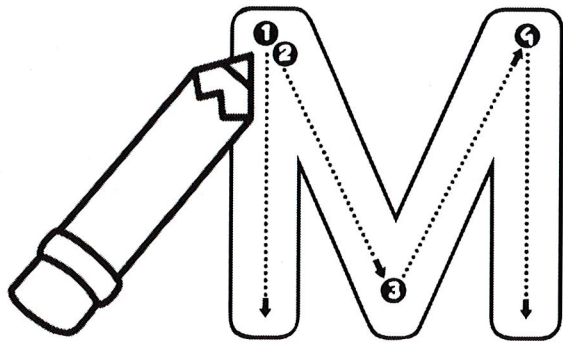

Tracing practice area consisting of four rows of horizontal lines. Each row contains five dashed uppercase 'M' characters for tracing. A solid black dot is placed at the top of each 'M' to indicate the starting point. The rows are decorated with small icons on the left side: a sun behind a cloud, an airplane, grass, and a caterpillar.

Name: _____

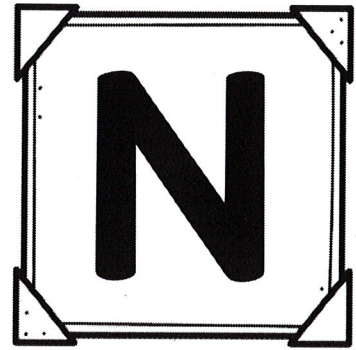
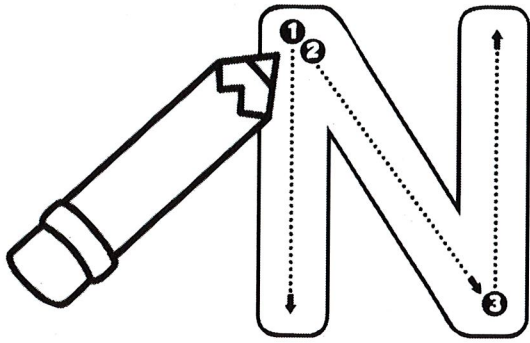

Handwriting practice section consisting of four rows of three-line guides (top, middle dashed, bottom). Each row contains six large, light gray 'N' characters for tracing. Each 'N' has a solid black dot at its top-left corner. To the left of each row are four small icons: a sun behind a cloud, an airplane, a tuft of grass, and a caterpillar.

Name: _____

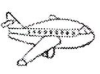
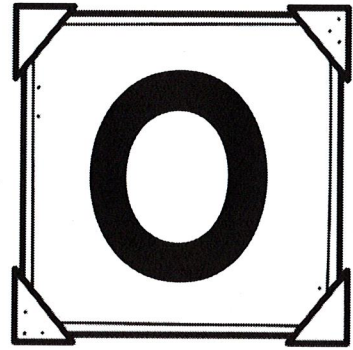
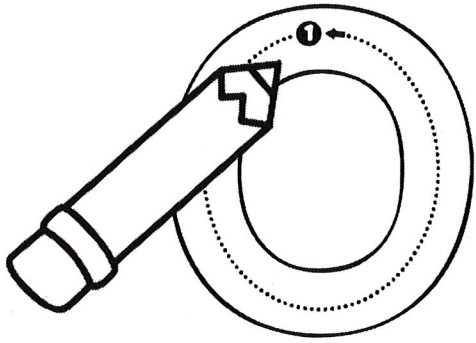

Handwriting practice area consisting of four rows of three-line guides (top solid line, middle dashed line, bottom solid line). Each row contains five large, hollow 'O' characters for tracing. Each 'O' has a small black dot at the top center and a dashed line following its circular path. The rows are decorated with small icons on the left side: sun/cloud, airplane, grass, caterpillar, sun/cloud, airplane, grass, caterpillar, sun/cloud, airplane, grass, caterpillar.

Name: _____

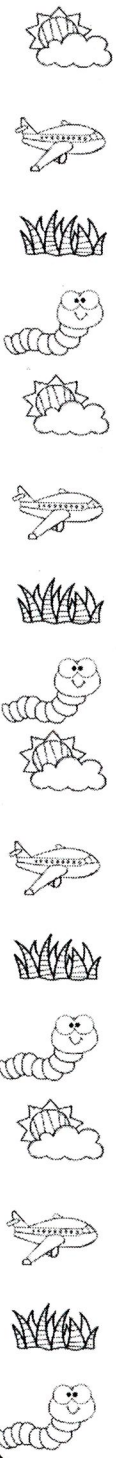
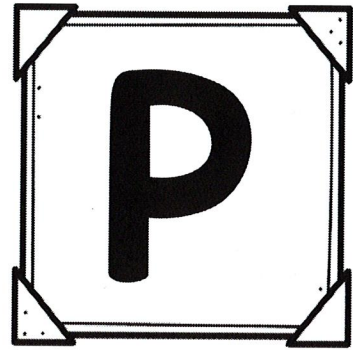
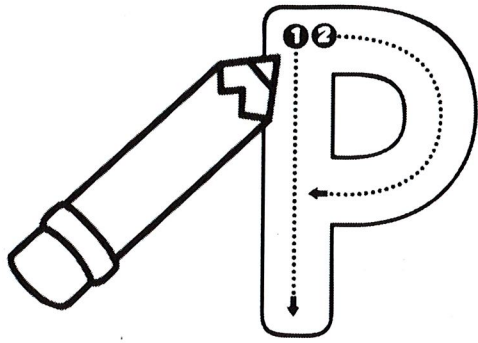

Handwriting practice section consisting of four rows of three-line guides (top, middle dashed, bottom). Each row contains six large, light gray uppercase 'P's for tracing. Each 'P' has a small black dot at the top of its vertical stem to indicate the starting point.

Name: _____

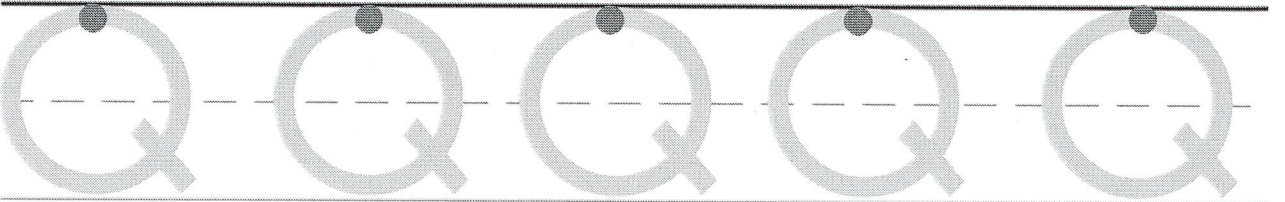
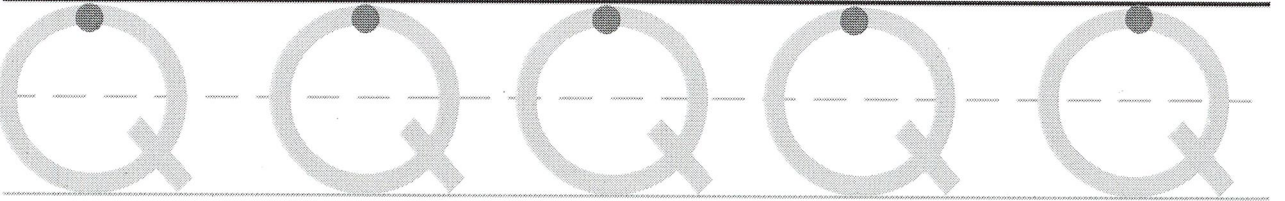
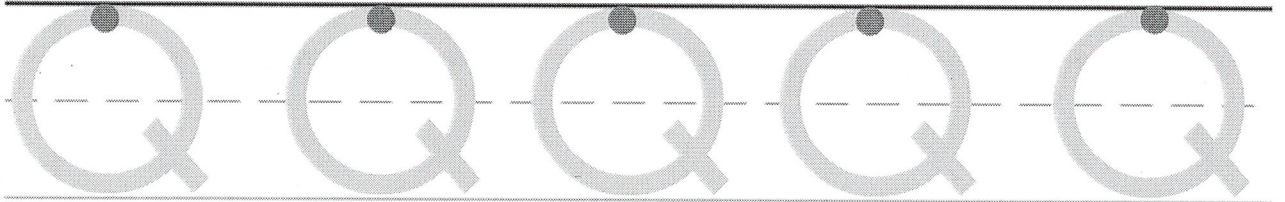
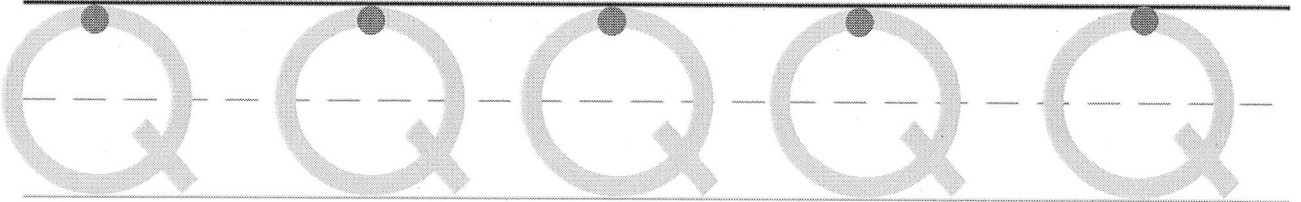
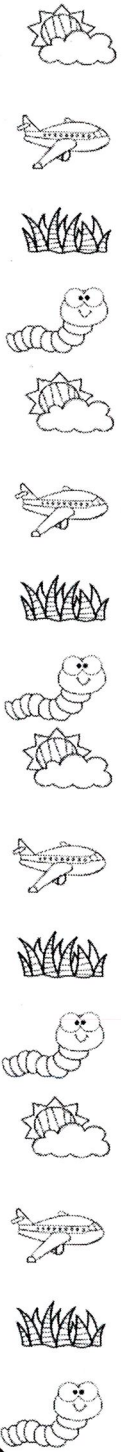
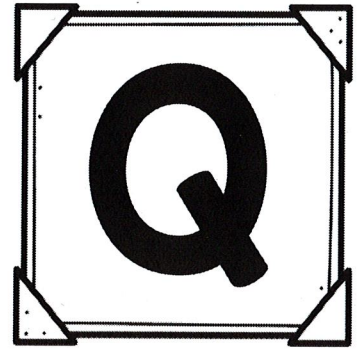
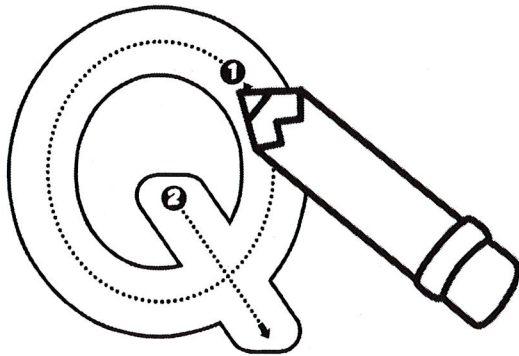

Name: _____

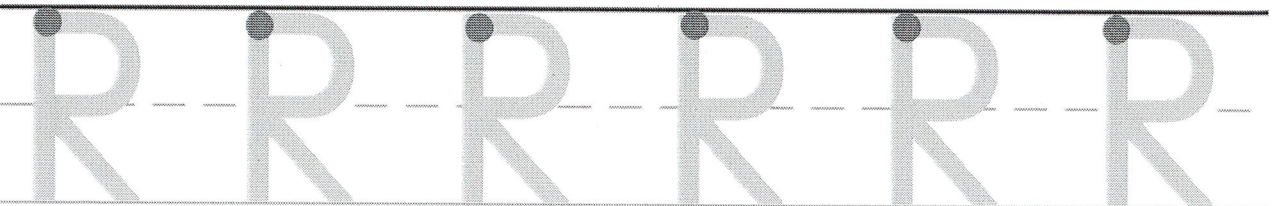
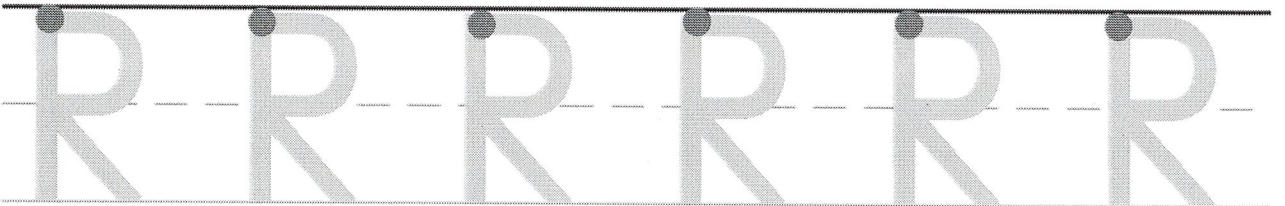
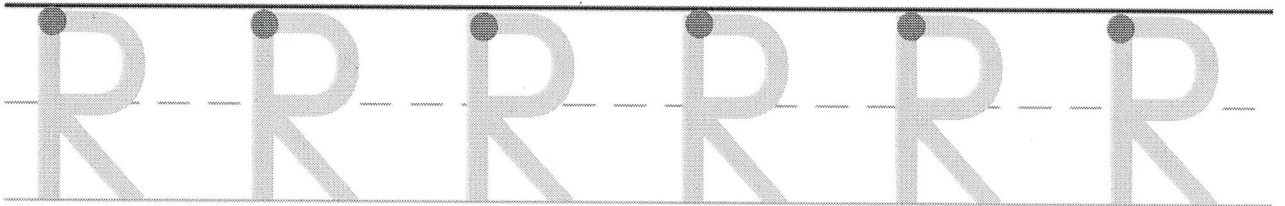
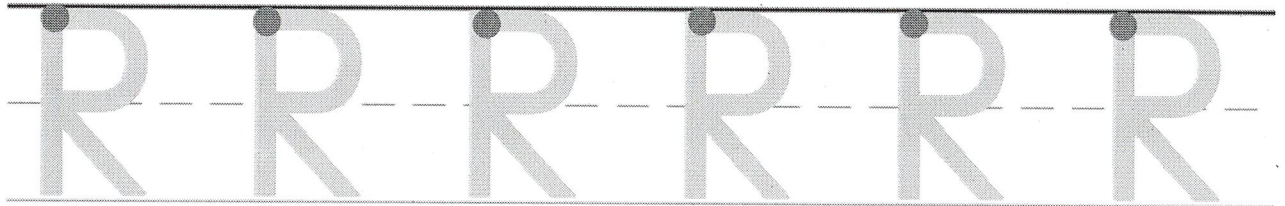
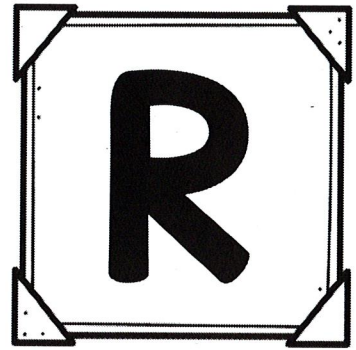
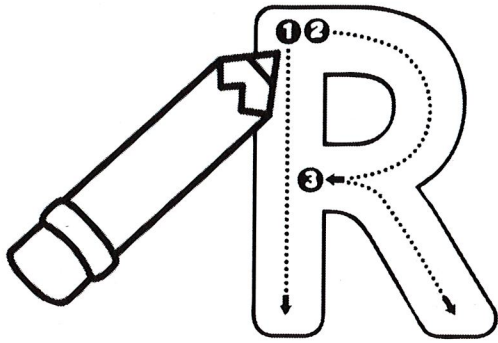

Name: _____

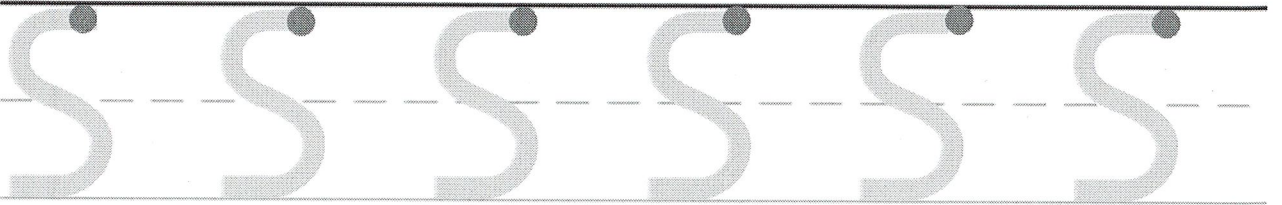
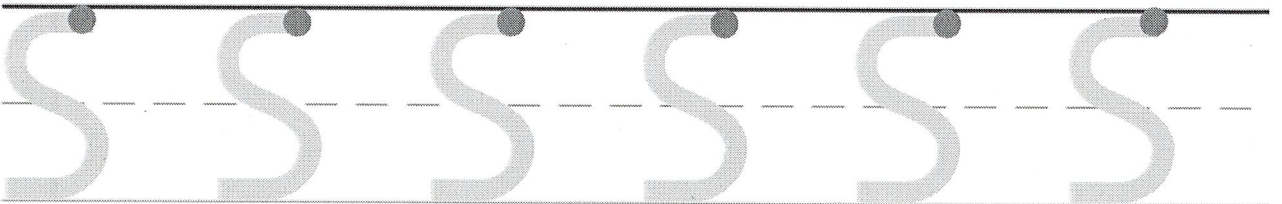
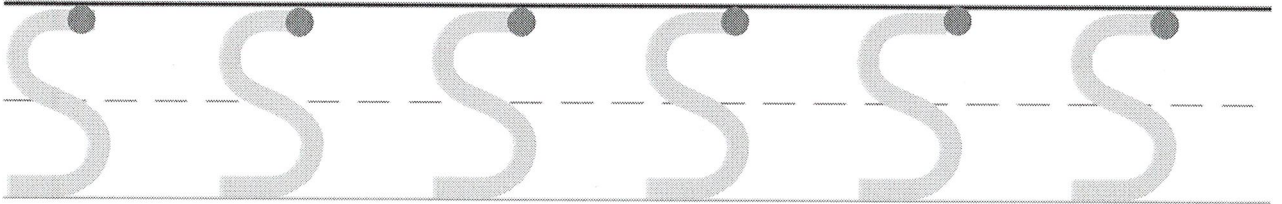
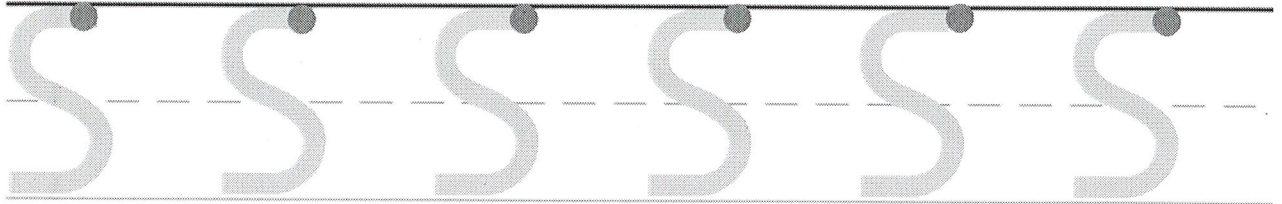
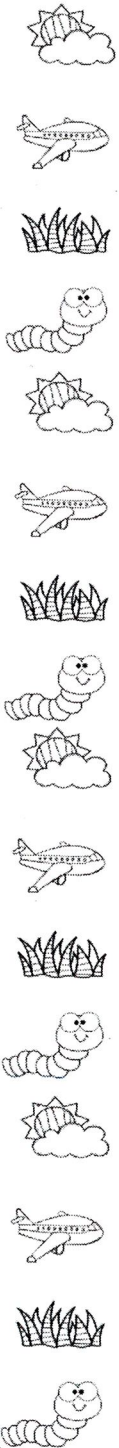
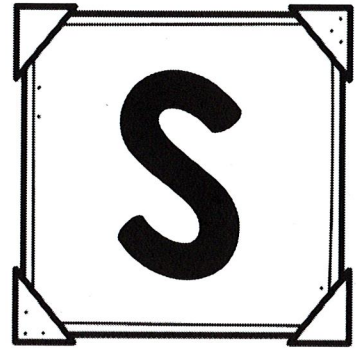
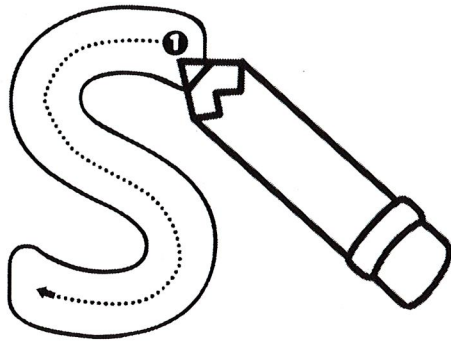

Name: _____

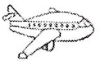
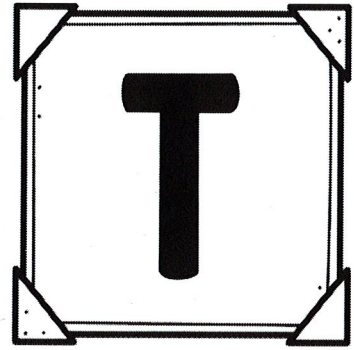
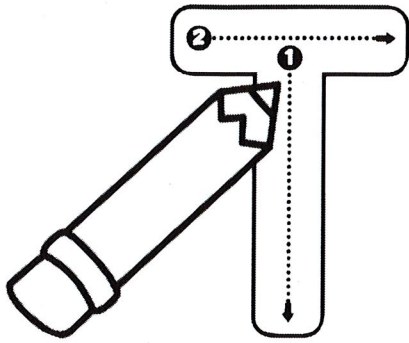

Handwriting practice area consisting of four rows of horizontal lines. Each row has a solid top line, a dashed middle line, and a solid bottom line. The first two rows each contain six dashed uppercase 'T' characters for tracing. The last two rows are blank for independent practice.

Name: _____

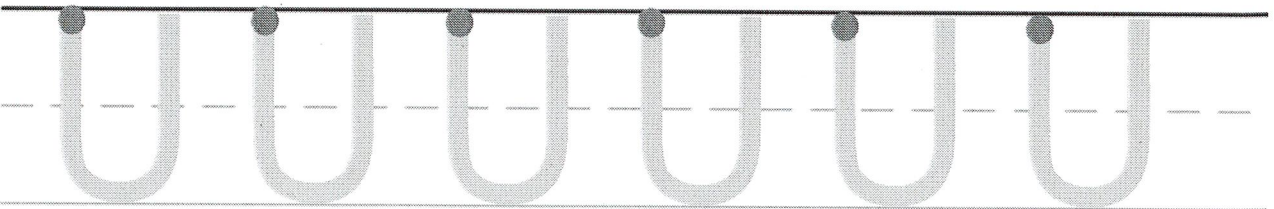
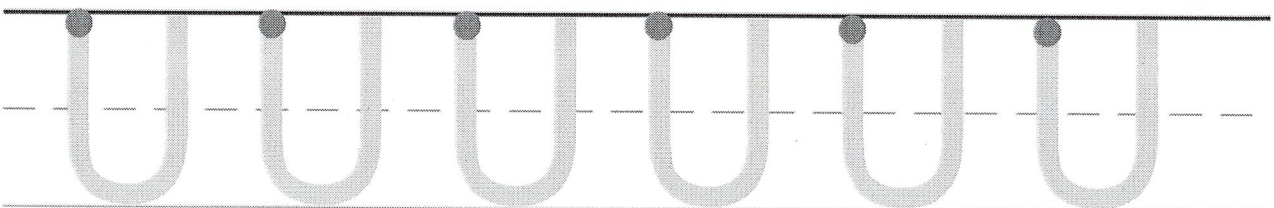
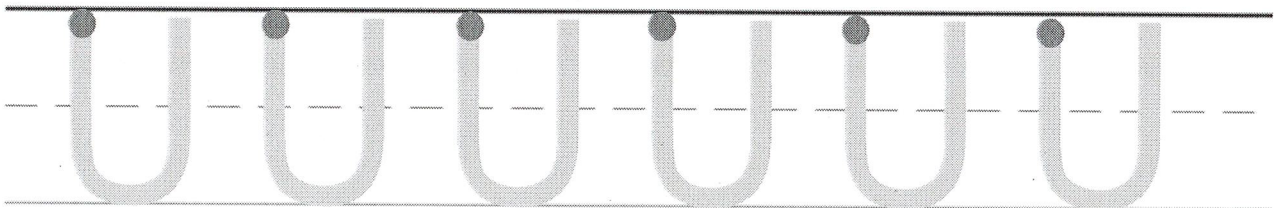
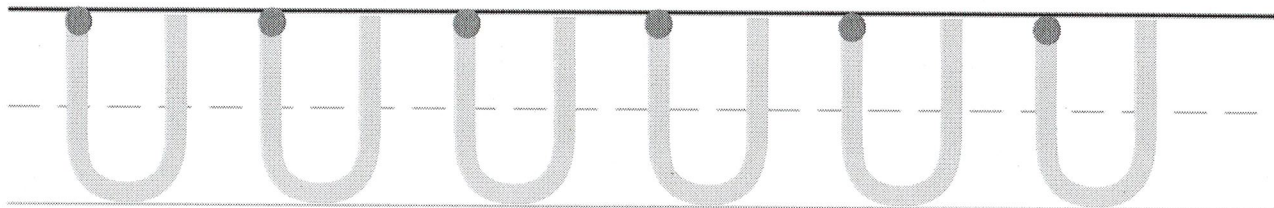
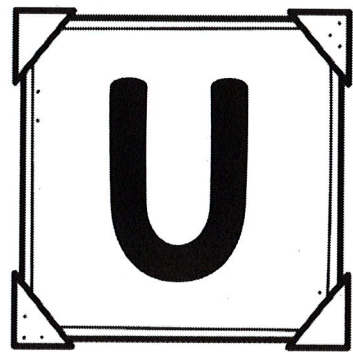
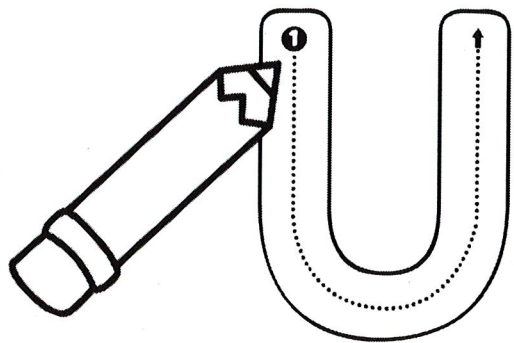

Name: _____

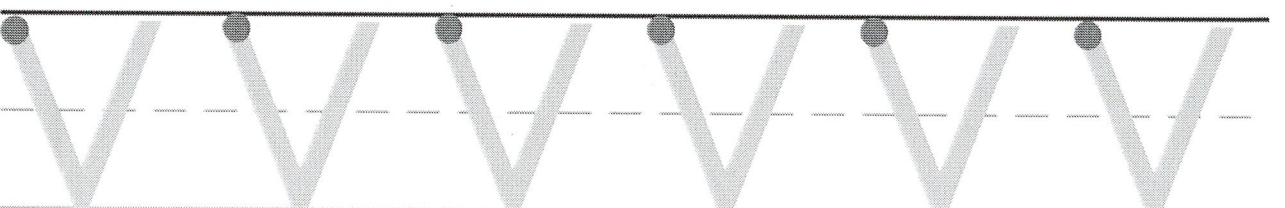
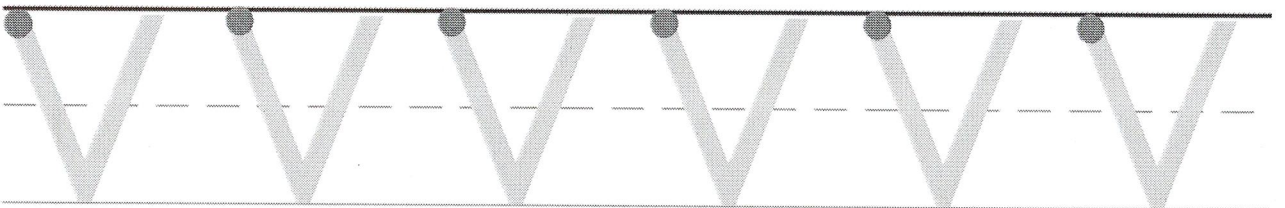
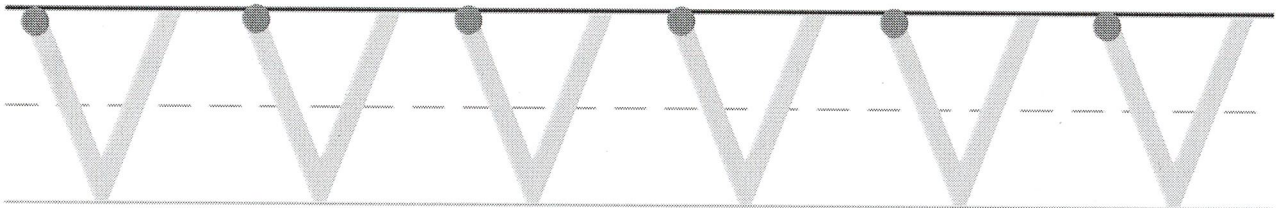
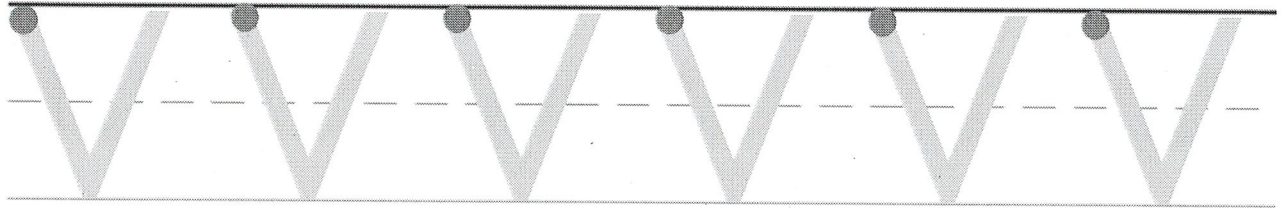
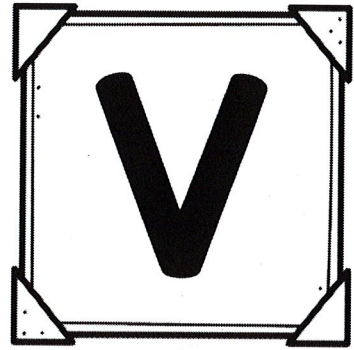
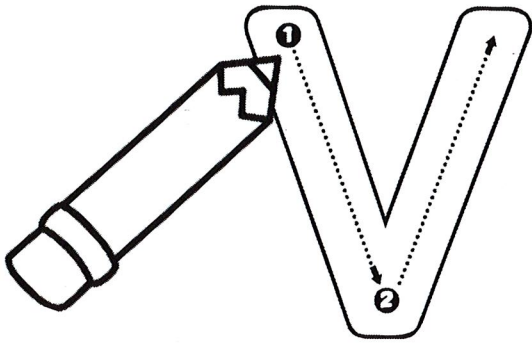

Name: _____

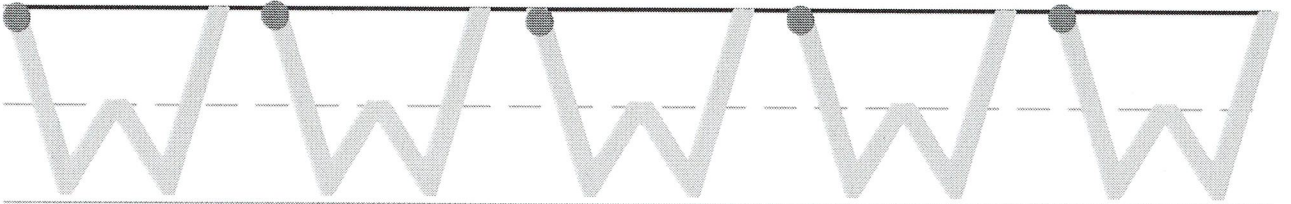
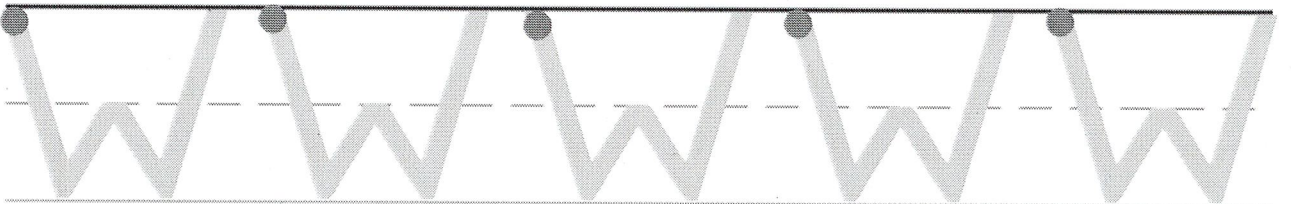
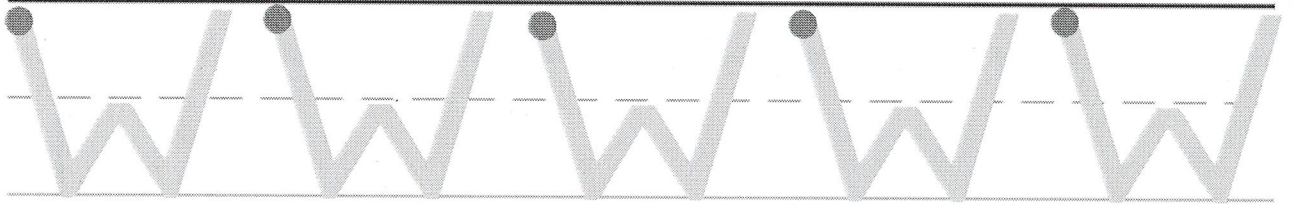
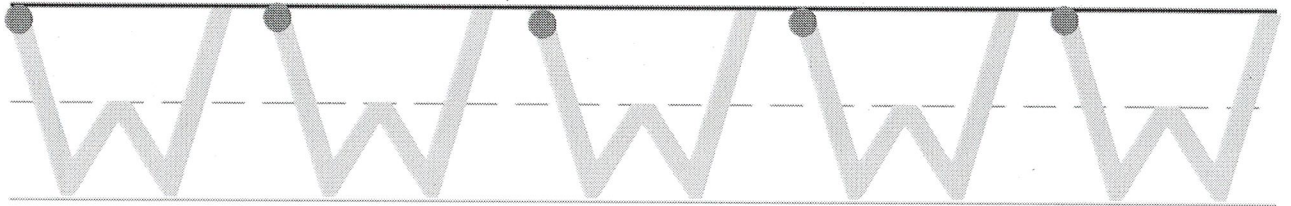
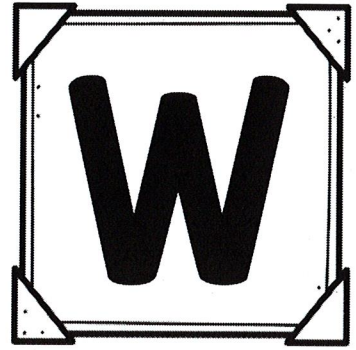
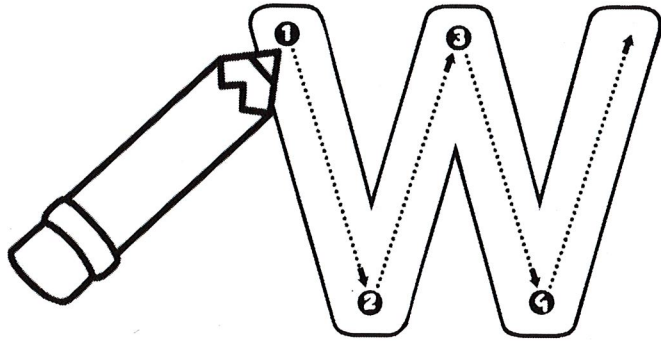

Name: _____

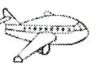
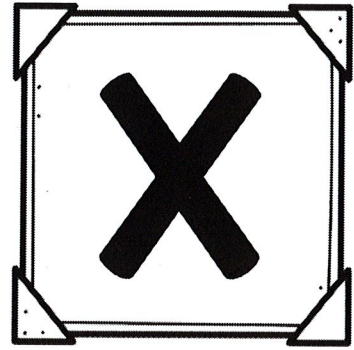
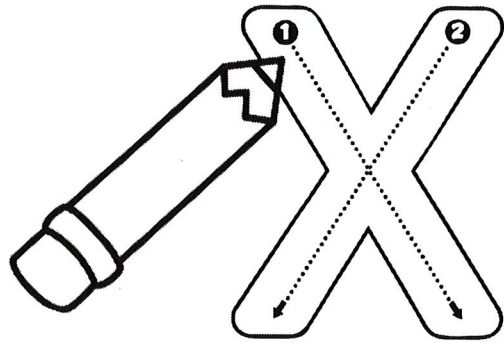

Handwriting practice area consisting of four rows of three-line guides (top solid line, middle dashed line, bottom solid line). Each row contains six faint 'X' shapes for tracing, each starting with a solid black dot at the top-left position. The first row also has a solid black dot at the top-right position for each 'X'.

Name: _____

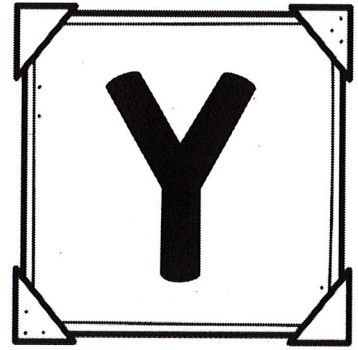
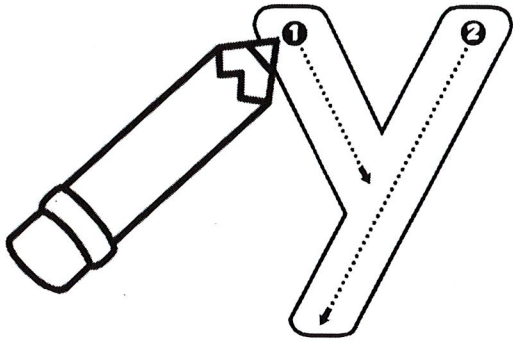

Handwriting practice area consisting of four rows of three-line guides (top solid line, middle dashed line, bottom solid line). Each row contains six faint, grey 'Y' characters for tracing. A solid black dot is placed at the top of each 'Y' to indicate the starting point for writing.

Name: _____

